

# Operating Manual

Mark Levinson®  
N°30.5  
Reference Digital  
Processor

Madrigal Audio Laboratories, Inc.

**WARNING:** TO REDUCE THE RISK OF FIRE OR ELECTRIC SHOCK, DO NOT EXPOSE THIS APPLIANCE TO RAIN OR MOISTURE.

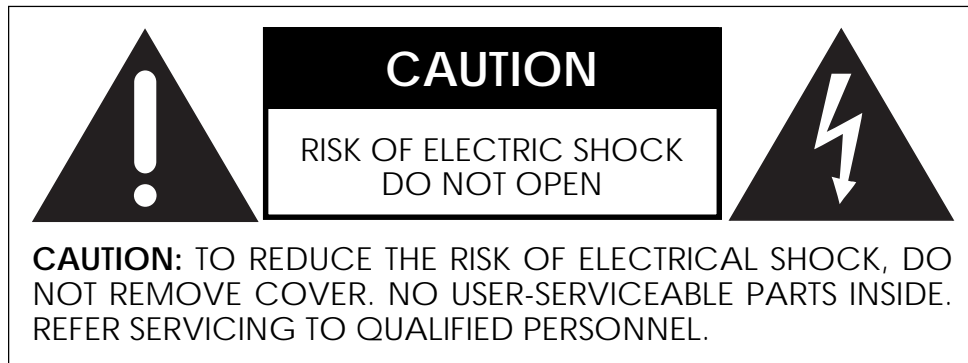

The lightning flash with arrowhead symbol, within an equilateral triangle, is intended to alert the user to the presence of uninsulated “dangerous voltage” within the product’s enclosure that may be of sufficient magnitude to constitute a risk of electric shock to persons.



The exclamation point within an equilateral triangle is intended to alert the user to the presence of important operating and maintenance (servicing) instructions in the literature accompanying the appliance.



Marking by the “CE” symbol (shown left) indicates compliance of this device with the EMC (Electromagnetic Compatibility) and LVD (Low Voltage Directive) standards of the European Community.

---

#### NOTICE

This equipment has been tested and found to comply with the limits for a Class B digital device, pursuant to Part 15 of the FCC Rules. These limits are designed to provide reasonable protection against harmful interference in a residential installation. This equipment generates, uses and can radiate radio frequency energy and, if not installed and used in accordance with the instructions, may cause harmful interference to radio communications. However, there is no guarantee that interference will not occur in a particular installation. If this equipment does cause interference to radio or television reception, which can be determined by turning the equipment on and off, the user is encouraged to try to correct the interference by one or more of the following measures:

- Reorient or relocate the receiving antenna;
- Increase the separation between the equipment and the receiver;
- Connect the equipment into an outlet on a circuit different from that to which the receiver is connected;
- Consult the dealer or an experienced radio/TV technician for help.

**CAUTION:** Changes or modifications to this equipment not expressly approved by the manufacturer could void the user’s authority to operate the equipment.

HDCD® and High Definition Compatible Digital® are registered trademarks of Pacific Microsonics, Inc.

The information contained in the manual is subject to change without notice. The most current version of this manual will be posted on our web site at <http://www.madrigal.com>.

# Important Safety Instructions

Please read all instructions and precautions carefully and completely before operating your Mark Levinson component.

1. **ALWAYS** disconnect your entire system from the AC mains before connecting or disconnecting any cables, or when cleaning any component.
2. This product is equipped with a three-conductor AC mains power cord which includes an earth ground connection. To prevent shock hazard, all three connections must **ALWAYS** be used. If your electrical outlets will not accept this type of plug, an adapter may be purchased. If an adapter is necessary, be sure it is an approved type and is used properly, supplying an earth ground. If you are not sure of the integrity of your home electrical system, contact a licensed electrician for assistance.
3. AC extension cords are not recommended for use with this product. If an extension cord must be used, be sure it is an approved type and has sufficient current-carrying capacity to power this product.
4. **NEVER** use flammable or combustible chemicals for cleaning audio components.
5. **NEVER** operate this product with any covers removed.
6. **NEVER** wet the inside of this product with any liquid.
7. **NEVER** pour or spill liquids directly onto this unit.
8. **NEVER** block air flow through ventilation slots or heatsinks.
9. **NEVER** bypass any fuse.
10. **NEVER** replace any fuse with a value or type other than those specified.
11. **NEVER** attempt to repair this product. If a problem occurs, contact your Mark Levinson® retailer.
12. **NEVER** expose this product to extremely high or low temperatures.
13. **NEVER** operate this product in an explosive atmosphere.
14. **ALWAYS** keep electrical equipment out of the reach of children.
15. **ALWAYS** unplug sensitive electronic equipment during lightning storms.

From all of us at Madrigal Audio Laboratories, thank you for choosing the Mark Levinson N°30.5 Reference Digital Audio Processor.

A great deal of effort went into the design and construction of this precision device. Used properly, it will give you many years of enjoyment.

# Table of Contents

<b>Unpacking and Placement</b> .....	<b>6</b>
Unpacking the N°30.5 .....	6
Placement of the N°30.5 .....	6
<b>Operating Voltage</b> .....	<b>7</b>
<b>A Quick Start</b> .....	<b>8</b>
Warm up/break-in period .....	9
<b>Special Design Features</b> .....	<b>10</b>
An Intelligent FIFO™ .....	10
Superior isolation between sources .....	11
Fully balanced design .....	11
24 bit digital architecture and HDCD® compatibility .....	11
<b>HDCD® Gain-Matching</b> .....	<b>12</b>
<b>Front panel, N°30.5</b> .....	<b>13</b>
<b>Display, N°30.5</b> .....	<b>16</b>
<b>Rear panel, N°30.5</b> .....	<b>18</b>
<i>Male XLR output connector (analog)</i> .....	18
<i>Linking connections</i> .....	19
<i>Building link cables</i> .....	19
<i>Female XLR input connector (digital)</i> .....	20
<i>Male XLR output connector (digital)</i> .....	22
<b>Rear panel, PLS-330</b> .....	<b>23</b>
<i>AC power cord polarity</i> .....	23
<b>Setup and Installation</b> .....	<b>24</b>
N°30.5 Input Names .....	24
Making Digital Connections .....	24
Making Analog Connections .....	25
Making Link Connections .....	25
Making Power Supply Connections .....	26
Naming Your Inputs .....	26
<b>Linked functions</b> .....	<b>28</b>
Record link .....	28
Standby link .....	28
Alias link .....	28
Play link .....	28
Display Link .....	28
Polarity link .....	29
HDCD Link .....	29
<b>Troubleshooting</b> .....	<b>30</b>
<b>Care and maintenance</b> .....	<b>31</b>
<b>U.S. and Canadian Warranty</b> .....	<b>32</b>
90-Day Limited Warranty .....	32
Five Year Extended Warranty .....	32
<b>Obtaining Service</b> .....	<b>33</b>
<b>Specifications</b> .....	<b>34</b>
<b>Dimensions</b> .....	<b>35</b>
<i>N°30.5 Front Dimensions</i> .....	35
<i>N°30.5 Rear Dimensions</i> .....	35
<i>N°30.5 Top Dimensions</i> .....	36
<i>PLS-330 Front Dimensions</i> .....	36
<i>PLS-330 Rear Dimensions</i> .....	36
<i>PLS-330 Top Dimensions</i> .....	37

# Unpacking and Placement

## Unpacking the N°30.5

Unpack your N°30.5 Reference Digital Processor and PLS-330 Power Supply and remove all accessories from the cartons. Keep all packing materials for future transport.

Included with your new Mark Levinson processor is a pair of knit, white gloves designed to assist you in the initial unpacking and placement of your new purchase. Please accept them as a token of our appreciation for having purchased one of our products.

## Placement of the N°30.5

The N°30.5 should be placed as close as possible to your digital source equipment, thus keeping interconnect cabling short. We strongly recommend shelf mounting to allow for proper ventilation. The N°30.5 is designed for continuous operation, which is why it features a **standby** mode rather than a full “off” mode—it is designed to be connected to the AC mains at all times for the best performance.

Three DC cables are provided to connect the PLS-330 to the N°30.5. Their lengths allow you to place the PLS-330 so that it won't induce hum in the N°30.5 and other sensitive components. (The best location for the PLS-330 is often near the floor, since it does not require any day to day user interaction). Other associated equipment should also be placed so that it doesn't induce hum in the N°30.5 and other sensitive components.

Be sure to allow 3 to 4 inches of clearance above both the N°30.5 and the PLS-330, to allow heat dissipation through air circulation.

Drawings are included in this manual to facilitate special installations and custom cabinetry (see “Dimensions”).

# Operating Voltage

The PLS-330 is set at the factory (internally) for 100V, 120V, 200V, 230V, 220V, or 240V AC mains operation @ 50 or 60Hz. (*230V/50Hz only in European Union countries, in compliance with CE regulations*) This voltage setting cannot be changed by the user. Make sure that the label on the rear panel of the PLS-330 (above the AC cord) indicates the correct AC operating voltage for your location.

If the voltage indicated on your PLS-330 is incorrect, or if you wish to change the AC operating voltage of your N°30.5/PLS-330 as the result of moving to a different country than the one in which you purchased your digital audio processor, see your Mark Levinson dealer.

The N°30.5/PLS-330 can be powered by a normal 15-ampere AC mains line. If other devices are also powered from the same AC line, their additional power consumption should be taken into account.

For optimal sonic performance and longevity, the N°30.5 is designed to remain powered at all times (the **standby** switch merely mutes the processor's outputs and turns off the display). There is an initial break-in period of approximately 300 hours before the N°30.5 achieves optimum performance.

# A Quick Start...

We recognize that many people are understandably eager to begin listening to their new components, and that reading the manual is often done (if at all) at a later time—perhaps while listening to music through the new product itself. We strongly recommend that you read this manual thoroughly, as the N°30.5 Reference Digital Audio Processor incorporates several unusual features which enhance its operation.

Fortunately, we can help you get some music up and running on your system quickly, so that you may begin enjoying your new preamplifier while reading more about it. The goal here is simply to make some music as quickly as possible.

The following procedure assumes that the rest of your system is already connected (e.g., preamplifier to power amplifier, to speakers, etc.).

## **1 TURN OFF YOUR ASSOCIATED COMPONENTS**

This minimizes the opportunity for a momentary electrical surge disturbing your system while making connections. If you have a large power amplifier, allow its power supply to fully discharge before proceeding (which may take as long as several minutes).

## **2 CONNECT A DIGITAL SOURCE TO EITHER INPUT 1 OR 4**

Inputs 1 and 4 on the N°30.5 are configured from the factory for CD transports, the most common type of digital transport. Input 1 is an aes/ebu (XLR-type) digital input; Input 4 is an S/PDIF (RCA-type) digital input. These digital inputs are found on the rear of the center section of the N°30.5. Use high quality digital cable such as Madrigal MDC-1 for XLR-type, or MDC-2 for RCA-type connections.

## **3 CONNECT A SET OF ANALOG OUTPUTS TO YOUR PREAMPLIFIER**

The N°30.5 has two identical sets of balanced (XLR) analog outputs and one set of single-ended (RCA) outputs. They are found on the two towers (which house the analog circuitry). As viewed from the *front*, the left tower contains the Left channel and the right tower contains the Right channel. Use high quality cable such as Madrigal HPC.

## **4 CONNECT THE POWER SUPPLY LEADS FROM THE PLS-330 TO THE N°30.5**

There are three power supply leads which run from the rear of the PLS-330 to the rear of the N°30.5. The analog DC cables for the left channel and the right channel towers use special five-pin connectors on both ends. The digital DC cable for the center section uses a two conductor connector at each end. These cables are not directional.

- 5 CONNECT THE AC CORD TO THE PLS-300 AND TO YOUR AC OUTLET**  
The AC receptacle for the power cord is located underneath the PLS-330, in the center of the unit. (This design reduces noise by bringing the power into the chassis precisely where it is needed rather than routing it through-out the unit.) The N°30.5 will take a few moment to initialize and will then be ready to use.
- 6 SELECT THE INPUT YOU ARE USING BY PRESSING ITS FRONT PANEL BUT-TON**
- 7 TURN ON THE OTHER COMPONENTS; SLOWLY RAISE THE VOLUME**  
Congratulations! You should now be able to enjoy your favorite music while reading the rest of this manual.

**Warm up/break-in period**

Although your Mark Levinson N°30.5 digital processor delivers outstanding performance straight out of the box, you should expect to hear it continue to improve as it reaches its normal operating temperatures and its various components "break-in." It has been out experience that the greatest changes occur within the first 25-50 hours, but that the N°30.5 will continue to improve in sound quality for about 300 hours, after which time it remains quite constant.

The only exception to this rule is if power is removed from the unit for an extended period, allowing it to cool down. In this case you should expect a brief warm-up period before the N°30.5's sound quality is at its best. (Fortunately, you will never have to repeat the full 300 hour break-in period.)

# Special Design Features

Congratulations on your purchase of the N°30.5 Reference Digital Audio Processor. The Madrigal design team is confident you will enjoy the outstanding performance of the N°30.5 for many years. In case you are interested in technical details, what follows is a brief outline of some of the key technologies in your new processor.

## An Intelligent FIFO™

Unlike previous processors which were highly dependent on the quality of the digital signal they were fed, the N°30.5 Reference Digital Audio Processor delivers outstanding performance with even less-than-ideal digital signals.

“FIFO” stands for “First In, First Out.” It describes a simple buffer in which the digital information is stored temporarily on its way to being converted to analog. Just as a large water tower can provide a steady source of water to a small town, despite hour-to-hour variations in the supply of water from the well, a FIFO can provide a steady, consistent source of digital data to the converters which are responsible for changing that data into music. Even if there is significant “jitter” (inconsistencies in timing) in the incoming digital information, the output of the FIFO is controlled by a special clock with tremendous accuracy. The result largely eliminates the jitter and allows the musical information to be reproduced cleanly, without jitter-induced distortions.

The trouble with most FIFOs lies in their behavior when the incoming signal is poor enough to cause the “water tank” to overflow or to be emptied. Normally, a FIFO would then have to “invent” false data to fill the gap, throw away excess data, or revert to non-FIFO operation. None of these approaches are acceptable.

Of course, you could simply use an *extremely* large buffer. Unfortunately, this solution is a poor one.

A larger buffer implies a longer delay between when information goes in and when it starts coming back out. With laserdiscs, for example, you must keep the in/out delay small so as to keep the soundtrack synchronized with the picture on the screen. An oversized buffer would make every movie’s audio out of step with its video, an unacceptable situation. It is possible to bypass the FIFO for movies, but you then lose all of its distortion-reducing benefits.

Madrigal engineers have developed a proprietary buffer management scheme which reduces reproduced jitter to less than 20 picoseconds while maintaining the synchronization of sound and picture in movies. It employs a buffer large enough to absorb the jitter found in transports of reasonable quality, yet small enough to have imperceptible delay. The rate at which data is released from the FIFO buffer is controlled by software to track the *long-term* data rate of the incoming signal, allowing the buffer to absorb all the short-term variations which cause sonic degradation. This approach yields a “smart” FIFO buffering scheme which rejects virtually all incoming jitter without requiring an enormous buffer and the consequent audible delay. It also avoids the sonic penalties associated with the usual strategies used when a buffer overflows or empties.

The “smart” FIFO operates at both 44.1 kHz and 48 kHz sampling rates. The N°30.5 reverts to non-FIFO (recovered clock) operation for 32 kHz sampling rates (a proposed but rarely used standard for digital satellite transmission). It also re-

verts to the recovered clock when the long-term data rate from the transport is extremely inaccurate. (Sorry—the digital output of your CD portable will not sound as good as a fine CD transport such as the Mark Levinson N°31.)

**Superior isolation  
between sources**

One of the advantages of a separate digital audio processor is that you can take the money which might have otherwise been spent on several built-in D/A converters and put it into one, superior processor which will enhance the performance of all the transports with which it is used. Ironically, many outboard processors fail to live up to this potential due to interference between their various digital inputs.

The N°30.5 provides outstanding isolation between its inputs, realizing the full potential of the various digital transports with which it is used. In fact, all unselected digital inputs are capacitively shunted to ground upon entering the N°30.5 to prevent their interaction with any portion of the circuitry inside the processor. As a result, the selected input effectively has the N°30.5 “all to itself” for its conversion to analog.

**Fully balanced design**

The N°30.5 is fully balanced in both the analog and digital domains. Even single-ended digital inputs (anything other than the balanced aes/ebu standard) are immediately converted to balanced signals before any further routing or processing of the signal. All digital filtering and processing is implemented in a balanced configuration, and conversion to analog is accomplished in two opposing polarity 20-bit converters per channel.

This approach maintains the integrity of the signal, reducing the opportunities for music-destroying noise and digital artifacts to enter the signal path.

**24 bit digital architecture  
and HDCD® compatibility**

All digital filtering and processing maintains a true 24-bit throughput capability, providing greater digital resolution than any existing source component. Even the most stringent requirements of professionals can easily be met with this design.

In addition to true 20-bit capability (24 bits in the digital domain, filtered to the 20-bit resolution of the digital to analog conversion stages), the N°30.5 also incorporates High Definition Compatible Digital® decoding to take full advantage of the increased resolution available from HDCD encoded 16-bit CDs. The High Definition Compatible Digital® format retains much of the resolution inherent in professional twenty bit recordings by encoding this information more efficiently within the sixteen bit space available within the Compact Disc format.

The technology embodied in the N°30.5 qualifies it as a genuine Reference product, one which will stand the test of time.

# HDCD® Gain-Matching

Some HDCD-encoded recordings are mastered at a level which is noticeably lower (6 dB) than conventional recordings. To avoid unexpected changes in volume when going from one disc to another, the N°30.5 automatically reduces the volume of all recordings to this “lowest-common-denominator” volume level, as required by Pacific Microsonics, Inc. Thus, this “HDCD AUTO” gain-matching is the default setting as shipped from the factory.

In our listening tests, we have determined that the only sonically transparent gain-matching technique is to raise the volume of the preamplifier by the requisite 6 dB when playing those few discs which require it. ***All other design options introduce a compromise in sound quality.***

For Best Performance:

---

*We strongly recommend that you turn off the HDCD AUTO gain-matching in your N°30.5 digital audio processor.*

---

**If you are using the N°30.5 with a Mark Levinson N°38 or N°38S preamplifier**, simply name the appropriate input on the preamplifier “No30” (explained in the preamp manual), and connect the two products with a Communications Link cable. In this case, the N°30.5 will tell the preamplifier to change its volume setting as necessary to compensate for differing CD mastering techniques, and you never have to think about it. (*The N°38 display will show “HD+6” to indicate a change required by the HDCD recording being played through the N°30.5; it will revert to normal and show “HD+0” when you return to conventional recordings. Older preamplifiers may require a new EPROM to take advantage of this feature.*) This technique ensures that you always get the best possible sound from your system, without any unexpected changes in level, with all recordings.

**If you are using the N°30.5 with any other preamplifier**, follow the steps below. (You will have to turn up the volume manually on some HDCD discs.)

**1 PRESS AND HOLD THE DIGITAL RECORD SELECT BUTTON**

After a few seconds, the display will change to show NAME and the current name of the selected input. (Ignore this for now. You'll learn how to rename your inputs to match your sources a bit later in this manual.)

**2 PRESS THE POLARITY BUTTON UNTIL THE DISPLAY SHOWS “HDCD MANUAL”**

Repeatedly pressing the polarity button will toggle the display between “HDCD AUTOMATIC” (*meaning that the output level of the N°30.5 will be automatically adjusted to compensate for the differences in recording level between some HDCD discs and conventionally-mastered discs*) and “HDCD MANUAL” (*meaning that gain-matching is turned off; HDCD-encoded discs will still be decoded properly*). If you to change this mode of operation while a N°38 is Linked, the N°30.5 will display “No38 ACTIVE!” (indicating that the N°30.5 and N°38 will override your action).

In this case, you will have to turn up the volume on some HDCD recordings manually. This is no great hardship, since most people adjust the volume of their systems from one recording to the next in any event. Changing to “manual” gain-matching ensures that the HDCD digital filter always operates at its maximum resolution.

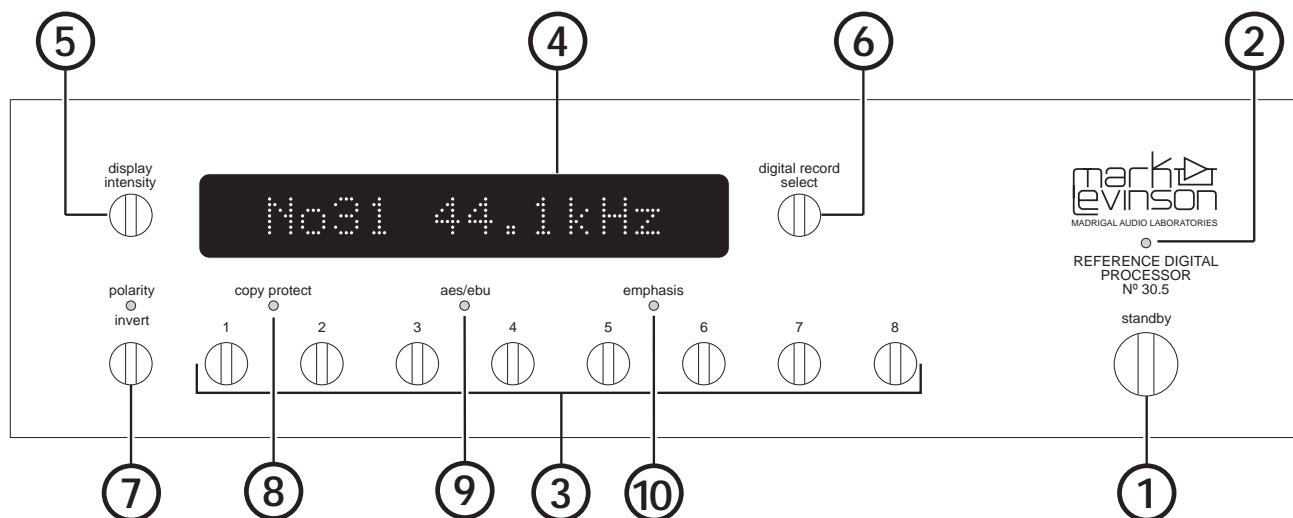

## Front panel, N°30.5

- 1 STANDBY**  
 Provided the N°30.5 is connected to AC power (via the PLS-330), pressing this button takes the N°30.5 out of “standby” mode, turns the **display** on, and enables the front-panel controls.

Pressing **standby** again places the N°30.5 into standby mode, turns the **display** off, turns off all outputs (including the record outputs), and disables the front-panel controls.
- 2 STANDBY LED**  
 While the N°30.5 is in standby mode, this LED flashes approximately every five seconds. When the N°30.5 is ready to operate (that is, when it is not in standby mode), this LED remains lighted.
- 3 SOURCE SELECTION BUTTONS**  
 Pressing these buttons selects the digital source, according to the input connections on the rear panel (see “Rear panel, N°30.5”). Only one source at a time may be selected.

When power is first applied to the N°30.5 (or when power is restored after an interruption), it will search for and select the first input with an active digital signal. If none is found, it will select the first named source. As delivered from the factory, this input will be “AUX1.”

When the N°30.5 is taken out of standby mode, the source last selected before going into **standby** will be automatically selected.
- 4 DISPLAY**  
 See “Display, N°30.5” beginning on page 12.

## 5 DISPLAY INTENSITY

Pressing this button varies the brightness of the **display**. Four brightness levels are available.

When power is first applied to the N°30.5 (or when power is restored after an interruption), the **display** is automatically set to its brightest level.

Pressing the **display intensity** button once dims the **display** one level; pressing it again dims it further; pressing it again turns the **display** off. Pressing **display intensity** once more returns the **display** to its brightest level.

## 6 DIGITAL RECORD SELECT

Pressing **digital record select** button allows you to select the digital source you want to record to your digital recorder. It is possible to record a different digital source than the one selected for listening.

To record a digital source connected to the N°30.5, press **digital record select**. The N°30.5's display will show **RECORD** followed by the source currently selected. For example:



If you want to record a different source than the one currently selected, press the corresponding source selection button; the display will then show the input number of that source (for example, **RECORD CD2**).

To disable the record output, press the button again for the source which is currently selected to be recorded. The display will read **RECORD OFF** and the digital output of the N°30.5 will be temporarily disabled, eliminating any potential interaction between the record output circuitry of the N°30.5 and the rest of your system. Repeatedly pressing the button for the currently selected recording source will toggle the N°30.5 between **RECORD OFF** and that source. Selecting record for an unused input (see *N°30.5 Input Names*, p.24) will also cause the N°30.5 to display **RECORD OFF**.

After a few seconds, the Display will return to normal.



**Caution!**

---

*When using a digital recorder (like a DAT) that also allows recording of analog signals, a specific combination of interconnections and settings on the digital recorder, the N°30.5, and an associated preamplifier may create a "feedback loop" that may damage your system's loudspeakers. For guidance in avoiding such a feedback loop, consult your Mark Levinson dealer.*

---

## 7 POLARITY INVERT

Pressing this button inverts the polarity of the digital signal, to compensate for polarity differences during the recording process. Some recordings may simply "sound better" when this function is active.

While **polarity invert** is selected, the LED above the button will light.

**Note:** **polarity invert** doesn't affect the digital outputs, and isn't available for inverting the polarity of digital signals to be recorded.

**Note:** **polarity invert** may be operated by infrared remote control, but only when the N°30.5 is connected to compatible Mark Levinson components such as the N°31 Reference CD Transport. Complete instructions are included in those components' operating manuals.

## 8 COPY PROTECT LED

This LED lights when the N°30.5 detects encoded copy protection in the digital program being processed.

## 9 AES/EBU LED

The **aes/ebu** LED lights when the N°30.5 detects that the digital program being processed conforms to the AES/EBU (*Audio Engineering Society/European Broadcast Union*) professional standard. This LED indicates the presence or absence of certain encoded information in the digital signal. It does *not* indicate that the AES/EBU connections (a connection standard written by the same group) are being used. Playback of non-AES/EBU CDs or DATs won't activate the **aes/ebu** LED, even if the associated transport is connected according to the AES/EBU standard

## 10 EMPHASIS LED

The compact disc standard, as created by Sony and Philips, allows a high-frequency boost to be employed during recording. This boost, called recording pre-emphasis, increases the signal-to-noise ratio at high frequencies, but must be countered by a high-frequency cut before playback to restore a recording's normal frequency response. De-emphasis may be done as the recording is being mastered, or the compact disc (or digital audio tape) may be made with the pre-emphasis still on, and the de-emphasis performed in the playback unit.

In the N°30.5, the de-emphasis filtering is done in the digital domain.

The **emphasis** LED lights when the N°30.5 detects recording pre-emphasis in the digital program being processed, and subsequently employs its de-emphasis circuitry (see "Specifications").

**Note:** The de-emphasis circuitry of the N°30.5 is designed to be compatible with all known digital standards. However, it is possible for the emphasis LED to light in error when there is no disc being played. This is not a malfunction of the N°30.5. Rather, it is the result of the transport generating ambiguous signals in the absence of a spinning disc to read. You may never see this condition. Even when the condition exists, it has no effect on sonic quality, as it can only occur when there is no disc playing.

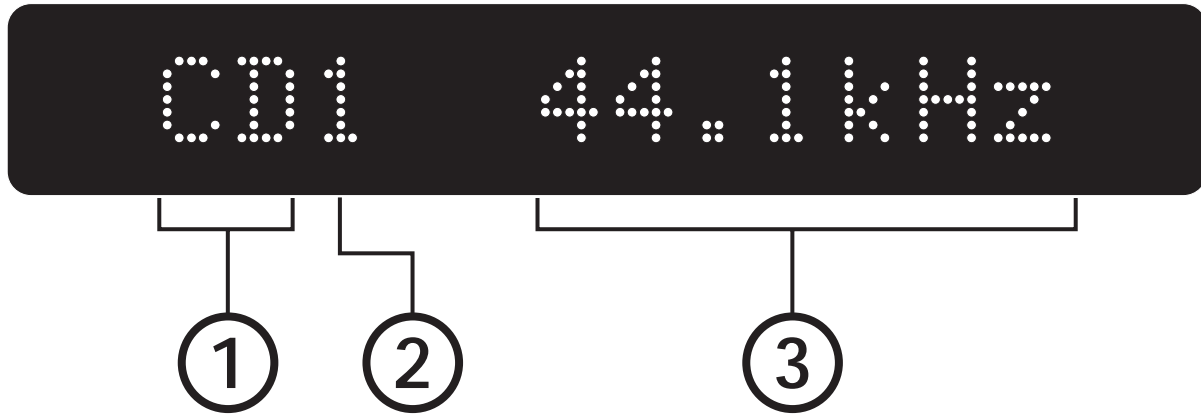

## Display, N°30.5

### 1 INPUT ALIAS

This part of the N°30.5's display shows the **name** of the input selected, as determined during setup (see "Assigning input names" in the "Installation" section of this manual).

To facilitate operation in complex, multi-source systems, the N°30.5 is capable of displaying a wide variety of names for each of its eight inputs. They are listed below.

---

NOT USED	(any unused input)
DAT	Digital Audio Tape
DCC	Digital Compact Cassette
MD	Mini Disc
CDR	Compact Disc, Recordable
CDI	Compact Disc, Interactive
DBS	Digital Broadcast Satellite
LD	Laser Disc
CD	Compact Disc
ADC	Analog to Digital Converter
AUX	Auxiliary (other digital sources)
DCA	Digital Cable Audio
PCD	Proceed Compact Disc player
PDT	Proceed Digital Transport
CDD	Compact Disc Drive

---

### 2 INPUT NUMBER

This part of the N°30.5's display shows the **input number** of the selected digital source, according to the connections on the rear panel (see "Rear panel, N°30.5").

### 3 SAMPLING FREQUENCY

This part of the N°30.5's display shows the **sampling frequency** of the digital input being processed, expressed in kilohertz (kHz). One of three sampling frequencies will be shown: 32kHz, 44.1kHz, or 48kHz.

After you press one of the source selection buttons, the N°30.5 will reduce the volume and the display will show:



While the N°30.5 is attempting to lock onto a digital signal, the display will show:



If no digital signal is present (if the source is turned off, is improperly connected, or is disconnected), the display will show:



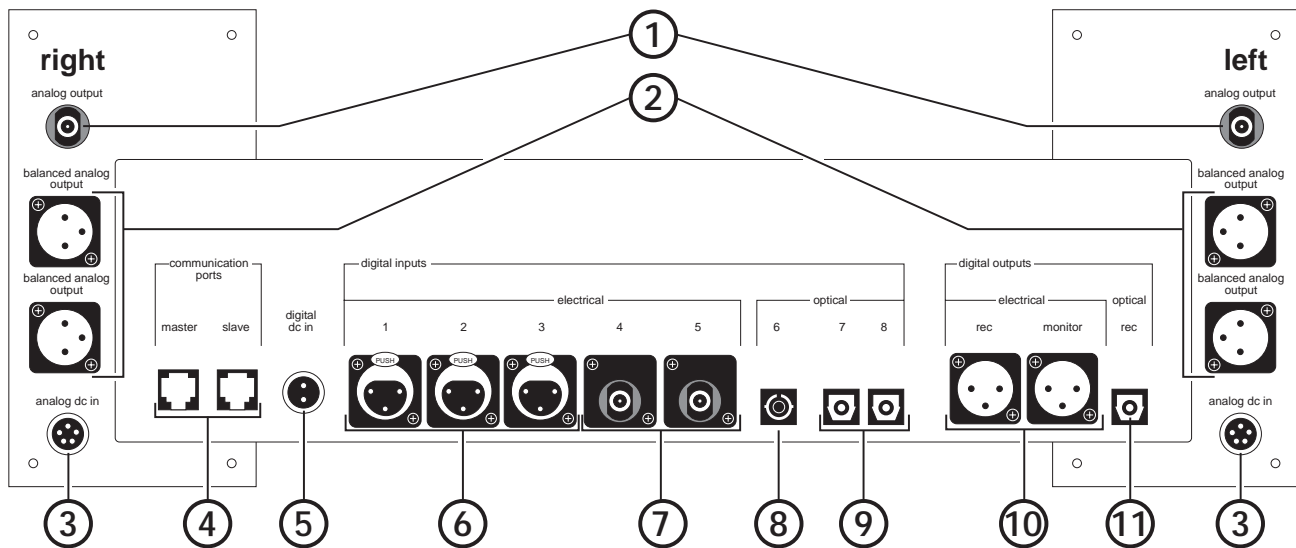

## Rear panel, N°30.5

### 1 ANALOG OUT

These outputs provide single-ended line-level analog audio (via cables equipped with RCA-type connectors) to a preamplifier, integrated amplifier, or receiver.



**Caution!**

*When using a digital recorder (like a DAT) that also allows recording of analog signals, a specific combination of interconnections and settings on the digital recorder, the N°30.5, and an associated preamplifier may create a "feedback loop" that may damage your system's loudspeakers. For guidance in avoiding such a feedback loop, consult your Mark Levinson dealer.*

### 2 BALANCED ANALOG OUTPUTS

These outputs provide balanced line-level analog audio (via cables equipped with XLR-type connectors) to a preamplifier, integrated amplifier, or receiver equipped with balanced inputs (see "Set-up and installation"). The pin assignments used are AES-standard, as shown below:

Male XLR output connector (analog)

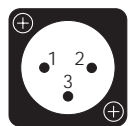

Pin 1: Signal ground  
 Pin 2: Signal + (non-inverting)  
 Pin 3: Signal - (inverting)  
 Connector ground lug: chassis ground

### 3 ANALOG DC IN

These inputs, one for each channel, accept DC power from the PLS-330 (via the supplied cables equipped with five-pin connectors).

Connect the left channels **audio dc in** on the rear panel of the N°30.5 to the **left audio dc out** on the rear panel of the PLS-330; likewise, connect the right channels **audio dc in** on the rear panel of the N°30.5 to the **right audio dc out** on the rear panel of the PLS-330.

#### 4 COMMUNICATION PORTS

These communications ports allow the N°30.5 to “link” to certain compatible Mark Levinson components. (See “Linked Functions.”)

The Mark Levinson Linking system uses the N°30.5 as the Master of (and central clearinghouse for) inter-component communications. Other components such as digital transports are connected to the Master as “Slaves,” and can be “daisy-chained” using their Slave In and Slave Out jacks. As the ultimate destination of all source signals, the N°38 or N°38S Preamplifier (if owned) *must* be the final “Slave” in the chain. (*In technical terms, it terminates the communications bus.*) In turn, the N°38 can serve as a master to an associated compatible Mark Levinson power amplifier—hence its “Master” communications port.

Thus, if the only other Mark Levinson Link-compatible component you have is the N°38 or N°38S, connect the N°30.5’s master port to the preamplifier’s slave port using a “straight-through” RJ-45 cable. If there are additional Mark Levinson Link-compatible components in the system, place the preamplifier at the end of the chain by connecting the last slave out port to the N°38’s slave port. See the diagram below for clarification.

The RJ-45 cable needed for the Link connection between the N°30.5 and other Link components may be purchased from your Mark Levinson dealer. It may also be easily and inexpensively made to length using two RJ-45 connectors and the appropriate length (up to 100 feet/30 meters) of RJ-45 (flat, eight conductor) cable.

RJ-45 cables and connectors are used throughout the world for both telecommunications and computers, and are widely available at low cost. The connectors are crimped on to the ends of the cable such that pin 1 at one end is connected to pin 1 at the other end. Such a “straight-through” connection is (counter-intuitively) made by introducing a 180° twist in the cable between the two ends, as shown below.

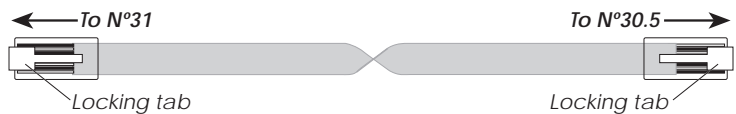
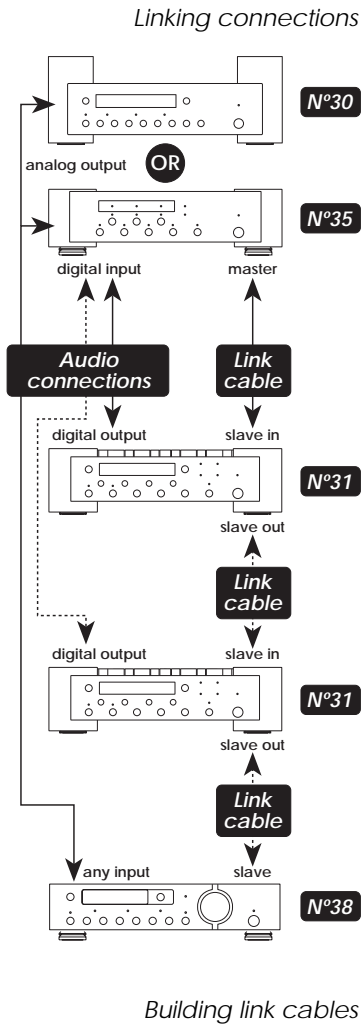

**Connecting the communication ports other than as described in this manual will damage the N°38 and the associated Mark Levinson components, and will void those products’ warranties.**

## 5 DIGITAL DC IN

This input accepts DC power from the PLS-330 (via the supplied cable equipped with two-pin connectors).

Connect **dc in (digital)** on the rear panel of the N°30.5 to the **dc out (digital)** on the rear panel of the PLS-330.

## 6 AES/EBU ELECTRICAL DIGITAL INPUTS (1 – 3)

These inputs accept the **digital audio signal (DAS)**, via cables equipped with XLR-type connectors) from digital sources such as a compact disc transport, laser disc transport, digital audio tape transport, digital broadcast receiver.

These inputs conform to the AES/EBU digital interconnection standard, which calls for a  $110\Omega$  transmission of the DAS. Use a digital interconnecting cable specifically designed for the  $110\Omega$  AES/EBU standard, such as Madrigal MDC-1 cable, when using these inputs. The pin assignments for the AES/EBU digital interconnection standard are shown below.

Female XLR input  
connector (digital)

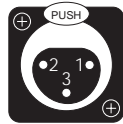

Pin 1: chassis ground  
Pin 2: Signal + (non-inverting)  
Pin 3: Signal – (inverting)  
Connector ground lug: chassis ground



**Caution!**

---

*When using a digital recorder (like a DAT) that also allows recording of analog signals, a specific combination of interconnections and settings on the digital recorder, the N°30.5, and an associated preamplifier may create a “feedback loop” that may damage your system’s loudspeakers. For guidance in avoiding such a feedback loop, consult your Mark Levinson dealer.*

---

## 7 S/PDIF RCA ELECTRICAL DIGITAL INPUTS (4 – 5)

These inputs accept the **digital audio signal (DAS)**, via cables equipped with XLR-type connectors) from digital sources such as a compact disc transport, laser disc transport, digital audio tape transport, digital broadcast receiver.

These inputs conform to the Sony/Philips Digital Interface Standard (S/PDIF), which calls for a  $75\Omega$  transmission of the DAS. Use a digital interconnecting cable specifically designed for the  $75\Omega$  S/PDIF standard, such as Madrigal MDC-2 cable, when using these inputs.



**Caution!**

---

*When using a digital recorder (like a DAT) that also allows recording of analog signals, a specific combination of interconnections and settings on the digital recorder, the N°30.5, and an associated preamplifier may create a "feedback loop" that may damage your system's loudspeakers. For guidance in avoiding such a feedback loop, consult your Mark Levinson dealer.*

---

**8 ST OPTICAL DIGITAL INPUT (6)**

This input accepts the digital audio signal (DAS, via cables equipped with the ST-type optical connector, sometimes called "AT&T") from digital sources such as a compact disc transport, laser disc transport, digital audio tape transport, digital broadcast receiver.



**Caution!**

---

*When using a digital recorder (like a DAT) that also allows recording of analog signals, a specific combination of interconnections and settings on the digital recorder, the N°30.5, and an associated preamplifier may create a "feedback loop" that may damage your system's loudspeakers. For guidance in avoiding such a feedback loop, consult your Mark Levinson dealer.*

---

**9 EIAJ OPTICAL DIGITAL INPUTS (7 - 8)**

These inputs accept digital audio signal (DAS, via cables equipped with the EIAJ optical connector, sometimes called "Toslink™") from digital sources such as a compact disc transport, laser disc transport, digital audio tape transport, digital broadcast receiver.



**Caution!**

---

*When using a digital recorder (like a DAT) that also allows recording of analog signals, a specific combination of interconnections and settings on the digital recorder, the N°30.5, and an associated preamplifier may create a "feedback loop" that may damage your system's loudspeakers. For guidance in avoiding such a feedback loop, consult your Mark Levinson dealer.*

---

*Male XLR output  
connector (digital)*

## 10 ELECTRICAL DIGITAL OUTPUTS

These outputs provide **digital audio signal (DAS)**, via cables equipped with XLR-type connectors) to a digital processor, digital audio tape recorder, pre-amplifier, integrated amplifier, or receiver equipped with XLR-type digital inputs.

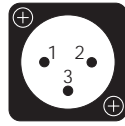

Pin 1: Chassis ground

Pin 2: DAS + (non-inverting)

Pin 3: DAS - (inverting)

Connector ground lug: chassis ground

The **monitor digital output** is controlled by the source selection buttons on the front panel. It can be used as a “pass-through” for the selected, monitored digital source, and employs the **aes/ebu** transmission standard.

The **rec digital output** is controlled by the **digital record select** button, and is unaffected by the **monitor** source selection buttons. It also employs the **aes/ebu** transmission standard.

## 11 OPTICAL DIGITAL OUTPUT

This output provides digital audio (DAS, via a cable equipped with EIAJ-type optical connectors) to a digital processor, digital audio tape recorder, preamplifier, integrated amplifier, or receiver equipped with optical digital inputs.

This **rec digital output** is controlled by the **digital record select** button, and is unaffected by the **monitor** source selection buttons.

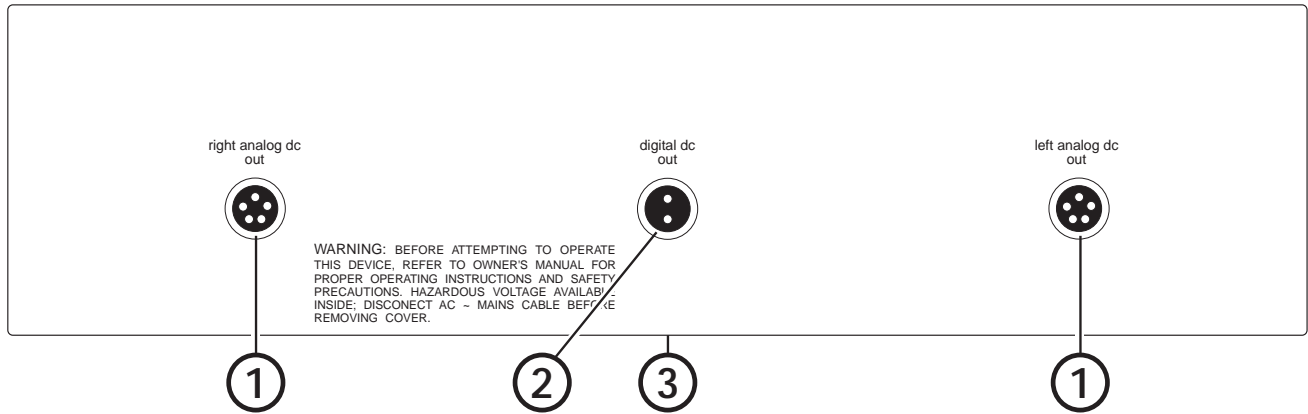

## Rear panel, PLS-330

### 1 RIGHT ANALOG DC OUT, LEFT ANALOG DC OUT

These outputs, one for each channel, provide DC power to the N°30.5 (via the supplied cables equipped with five-pin connectors).

Connect the left channels **analog dc in** on the rear panel of the N°30.5 to the **left audio dc out** on the rear panel of the PLS-330; likewise, connect the right channels **analog dc in** on the rear panel of the N°30.5 to the **right audio dc out** on the rear panel of the PLS-330.

### 2 DIGITAL DC OUT

This output provides DC power to the N°30.5 (via the supplied cable equipped with two-pin connectors).

Connect **digital dc in** on the rear panel of the N°30.5 to the **digital dc out** on the rear panel of the PLS-330.

### 3 AC POWER CONNECTOR (ON BOTTOM)

This input accepts AC power from the AC mains (via the supplied AC cable). Connect the female end of this cable to the PLS-330. Connect the male end of this cable to wall outlet or to an "unswitched" convenience outlet like those found on many audio components.

*AC power cord polarity*

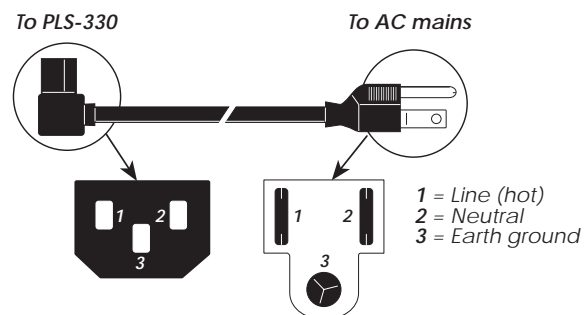

# Setup and Installation

## Caution!

*For your protection, review "Important Safety Instructions" before you install your N°30.5/PLS-330.*

## N°30.5 Input Names

The N°30.5 allows you to assign any of a wide variety of names to each of the eight digital inputs, shown below:

---

NOT USED	(any unused input)
DAT	Digital Audio Tape
DCC	Digital Compact Cassette
MD	Mini Disc
CDR	Compact Disc, Recordable
CDI	Compact Disc, Interactive
DBS	Digital Broadcast Satellite
LD	Laser Disc
CD	Compact Disc
ADC	Analog to Digital Converter
AUX	Auxiliary (other digital sources)
DCA	Digital Cable Audio
PCD	Proceed Compact Disc player
PDT	Proceed Digital Transport
CDD	Compact Disc Drive

---

The name you assign to an input is shown on the **display** when a source is selected (see "Display, N°30.5"). Before operating your N°30.5, you'll want to customize it to match the digital sources in your system.

The N°30.5 digital audio processor is shipped with inputs 1 and 4 named **CD**, since you will probably want to hook up your new component and start using it right away. **CD1** is an AES/EBU (XLR) digital input, and **CD4** is a S/PDIF (RCA) digital input, and both are ready for use as soon as the N°30.5 is powered up and connected to the rest of the system. Other inputs are named **NOT USED** and must be renamed before they may be used. (See "Making Digital Connections" and "Making Analog Connections" below.)

## Making Digital Connections

The N°30.5 incorporates RCA-type and XLR-type electrical connectors, and ST-type and EIAJ-type optical connectors for digital audio signal input. Digital outputs are available in both XLR-type electrical and EIAJ-type optical connectors. (See "Rear panel, N°30.5," above.)

Unlike previous generations of digital audio processors, the performance of which was highly dependent on the digital interface and the digital interconnect, the technology of the N°30.5 allows it to deliver optimal performance despite the inherent limitations of interfaces such as the EIAJ standard (sometimes called "Toslink™"). As a consequence, you can feel free to use whichever interconnection standard is convenient, given the provisions of your various digital sources.

For electrical digital interconnection, we recommend Madrigal MDC cable. MDC-1 is designed for AES/EBU interconnection (via XLR-type connectors); MDC-2 is designed for SPDIF interconnection (via RCA-type connectors). Both are available in various lengths from your Mark Levinson dealer.

Using appropriate cables, connect all your digital source components to suitable inputs on the rear panel of the N°30.5 processor. If you have several such components, you might want to make a note of which component is plugged into which input on a piece of scrap paper. (You will rename the various inputs in software shortly, making it easier to remember which input goes with which transport once the installation is complete.)

If you have several digital sources which have only S/PDIF (RCA) outputs, it is possible to use an RCA-to-XLR cable for connection to one of the N°30.5's XLR-type digital inputs. For the best performance in these circumstances, we recommend using a high-bandwidth (300 MHz), three conductor, 110Ω cable such as Madrigal MDC-1 (available from your Mark Levinson dealer). You may also fashion one according to the diagram below.

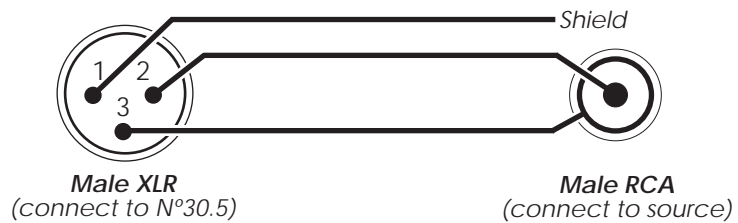

#### Making Analog Connections

The N°30.5 includes two sets of balanced and one set of single-ended analog outputs. The balanced outputs are generally preferred for their superior immunity to noise. All outputs operate at a line level.

*Note: the standard line level for balanced interconnection is six decibels higher than for single-ended interconnections*

For analog audio interconnection, we recommend Madrigal HPC Interconnect Cable. HPC is available from your Mark Levinson dealer, in various lengths and terminated with RCA, XLR, and Camac connectors.

Using high quality cable, connect the appropriate output of the N°30.5 to an input of your preamplifier. The output impedance of the N°30.5 is extremely low, which allows you to use more than one output simultaneously without degrading performance, should you have any reason to do so. For example, you might supply a multi-room system with the signal of the N°30.5 as well as your main music system.

#### Making Link Connections

The N°30.5 incorporates sophisticated inter-component communications capabilities when Linked to compatible Mark Levinson components. (See "Communications Ports" in "Rear Panel.") If you own compatible Mark Levinson digital source components or preamplifiers, connect them to the N°30.5 with an eight-conductor RJ-45 cable as described on page 18. You may find that you need to cycle power off and on once after making this connection for the first time (if making the connection to a previously operating component), in order to ensure that all components in the chain are aware of each other's presence.

## Making Power Supply Connections

After making all signal connections, connect the left channel's **analog dc in** on the rear panel of the N°30.5 to the **left audio dc out** on the rear panel of the PLS-330; likewise, connect the right channel's **analog dc in** on the rear panel of the N°30.5 to the **right audio dc out** on the rear panel of the PLS-330.

Connect **digital dc in** on the rear panel of the N°30.5 to the **digital dc out** on the rear panel of the PLS-330.

Connect the AC cord to the AC power connector on the bottom panel of the PLS-330, then connect the AC cord to the AC mains; the LED on the PLS-330 and the **standby** LED on the N°30.5 will light. After a few seconds, the N°30.5 will begin its self-test (the Display first shows **INITIALIZING**, then each of the eight input aliases, and finally **LOCKING** as it attempts to lock onto input 1).

The N°30.5 is now ready to operate.

For optimal sonic performance and longevity, the N°30.5/PLS-330 is designed to remain powered at all times. The **standby** button is provided so that you may turn off the display and disable the front-panel controls when the N°30.5 isn't in use (see "Front panel, N°30.5").

## Naming Your Inputs

All inputs other than 1 and 4 are labelled **NOT USED** as delivered from the factory, and will need to be given appropriate names before they are used. Giving inputs appropriate names is simple and greatly enhances the ease of use of your new N°30.5, especially for occasional users of the system. The available names are shown on page 24. To give an input a new name:

### 1 SELECT THE INPUT YOU WISH TO RENAME

Note that the input to be renamed needs to be the selected monitored input. The input which is currently selected to be sent out the digital record path is irrelevant to the renaming process.

### 2 PRESS AND HOLD THE DIGITAL RECORD SELECT BUTTON

After a delay of approximately five seconds, the display will change to **NAME = (the current name)**, as shown below. If the current name for the input is **NOT USED**, it will be abbreviated to **N.U.**



This message informs you that the N°30.5 is ready for you to change the input's name. (*Note that pressing and holding the digital record select button performs a different function than simply pressing it momentarily, which would allow you to select a source for the digital record path*)

**3 PRESS THE SELECTED INPUT BUTTON REPEATEDLY UNTIL YOU SEE THE NAME YOU WISH TO USE**

This action will cause the display to cycle through the list of available names, with the input number appended to the end of each name. For example, you might wish to change CD4 to LD4 if the digital output of your laserdisc player is plugged into the fourth input, in which case the display would appear as follows:



**4 PRESS AND HOLD THE DIGITAL RECORD SELECT BUTTON AGAIN, UNTIL "NAME CHOSEN" IS DISPLAYED**

Pressing and holding the digital record select button a second time confirms that you would like to make this change, that it is a conscious choice rather than an accidental change caused by an inquisitive four year old.



**5 REPEAT THIS PROCESS FOR ALL INPUTS**

# Linked functions

The N°30.5 has the ability to “link” six of its functions to compatible Mark Levinson components (like the N°31 Reference CD Transport and the N°38 or N°38S Preamplifier).

*Note: To take advantage of linked functions, you must connect the N°30.5 to the other components via their communication ports. (See “Rear panel” and “Set-up and installation.”)*

There are six linked functions.

## Record link

- **Record link:** While the N°31 is selected as the N°30.5’s recording source (a CD must be in play), this link helps prevent you from inadvertently disrupting the recording process. If you attempt to use any of the N°31’s functions that might disrupt the recording process (**Stop**, **LID Open/Close**, etc.), the N°30.5/31 combination will block that function and the N°31’s display will show **RECORDING**. Likewise, if you attempt to place the N°30.5 into **standby**, the N°30.5 will block that function and display will show **RECORDING**. To override the record link, press the function button **twice**. (*For example, if you **do** want to stop the CD that’s playing, even though it is being recorded, press the **Stop** button twice in succession.*)

## Standby link

- **Standby link:** This feature links the standby modes of the various Mark Levinson Linked components. For example:
  - If transport, digital processor and preamplifier are in standby mode, pressing the transport’s **standby** button will take all three components out of standby mode (making them ready to use).
  - If transport, digital processor and preamplifier are in standby mode, pressing the N°30.5’s **standby** button will bring only the preamp out of standby mode (presuming that you plan to use the N°30.5 with some digital source other than the N°31).
  - If transport, digital processor and preamplifier are “on” (not in standby mode), pressing the preamp’s **standby** button will place all three components into standby mode.

## Alias link

- **Alias link:** The N°31’s alias link automatically overrides the name setting for its input. When you select the N°31’s input, the N°30.5 will show **No31** on its display.

## Play link

- **Play link:** When you press the N°31’s **Play** button, this link automatically selects the N°31’s input on the N°30.5 and on the N°38 or N°38S.

*Note: If you’ve connected the N°31 to two or more of your N°30.5’s inputs, the play link will look first for AES/EBU interconnection, then S/PDIF, then ST, and finally EIAJ.*

## Display Link

- **Display link:** This links the **display intensity** functions of the N°30.5 and the other Linked components.

When the components are linked, all displays will be set to the same brightness. Pressing **display intensity** on either component will affect both displays.

Polarity link

■ **Polarity link:** This links the **d/a polarity** button on the N°31's Remote Control to the **polarity invert** function of the N°30.5. The polarity link also allows inverted polarity to be saved with a program, via the N°31.

The following Link is not a selectable option. Instead, it operates automatically and transparently between your transport, processor and preamplifier.

HDCD Link

■ **HDCD link:** When HDCD recordings are made, one of the encoding options chosen by the recording engineer results in a playback level that is six decibels lower than normal. This change in volume from one CD to the next is automatically compensated for when the N°30.5 is connected to a Mark Levinson preamplifier such as the N°38 or N°38S. When such a HDCD is played, the Linked preamplifier (acting on instructions from the digital processor) will automatically raise its volume setting by exactly six decibels. It will also reduce its volume setting by 6 dB when the low-output HDCD recording is no longer being processed. In this fashion, the perceived volume in the room is maintained at a constant level despite a fundamental change in the recording being played.

# Troubleshooting

In general, refer any service problems to your Mark Levinson dealer. Before contacting your dealer, however, check to see if the problem is listed here. If it is, try the suggested solutions. If none of these solves the problem, contact your Mark Levinson dealer.

1. **THE N°30.5 WON'T FUNCTION, AND THE DISPLAY IS DARK.**
  - ✓ The standby button on the front panel isn't turned on.
  - ✓ The PLS-330 isn't plugged into the AC mains.
  - ✓ The center (digital) section of the N°30.5 isn't receiving DC from the PLS-330 (double check the center section DC connection).
  - ✓ The wall socket, adapter, or extension cord is faulty.
  - ✓ There's a tripped circuit breaker or blown fuse in the wall outlet's circuit.
  - ✓ A fuse is blown in your PLS-330 (contact your Mark Levinson dealer).
2. **THE DISPLAY IS LIT, BUT THERE IS NO OUTPUT**
  - ✓ The proper source isn't selected on your N°30.5.
  - ✓ The proper source isn't selected on your preamplifier.
  - ✓ The interconnecting cables are connected incorrectly.
  - ✓ The Left and Right towers of the N°30.5 aren't receiving DC from the PLS-330 (double check their DC connections).
3. **THE N°30.5 DISPLAY READS "NO DAS."**
  - ✓ The selected digital source component is turned off.
  - ✓ The digital connection between the digital source and the N°30.5 is faulty.
  - ✓ The CD is inserted upside down in the CD transport.
4. **THE LINKED FUNCTIONS DON'T WORK.**
  - ✓ The Link cable is disconnected, or is connected incorrectly.
  - ✓ The digital audio cable is disconnected, or is connected incorrectly (in which case the Linked function would work correctly, but you might not be able to hear the results).
  - ✓ Try turning off/disconnecting AC power from both the N°31 and the N°30.5. After several seconds, restore AC power to the digital processor, **then** turn on the N°31's **main power** switch.
  - ✓ You may have older versions of the system software in your associated Mark Levinson components which do not fully support all Linked functions. Contact your Mark Levinson dealer with the model and serial numbers of your Mark Levinson components. If needed, new EPROMs will be provided at no charge.
5. **THE DISPLAY FLASHES "RECORDING"**
  - ✓ The Record Link is preventing you from interrupting an active digital record loop. Change the selected record input, or press the function button twice. (See *Record link*, page 28.)

# Care and maintenance

To remove dust from the cabinet of the N°30.5, use a feather duster. To remove dirt and fingerprints, we recommend isopropyl alcohol and a soft cloth.

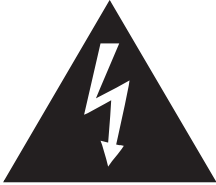

**Caution!**

---

*Always apply the isopropyl alcohol to the soft cloth and then wipe the N°30.5 with the dampened cloth. Never pour even small amounts of any liquid directly on the N°30.5, as doing so may allow the liquid to reach the circuitry inside the unit. Any liquid inside the unit poses a hazard to both the user and to the unit, and must be avoided.*

---

# U.S. and Canadian Warranty

## 90-Day Limited Warranty

This Mark Levinson® product is warranted to be free from defects in material and workmanship under normal use for a period of ninety (90) days from the date of purchase. **To extend the warranty of this Mark Levinson product**, return the warranty registration card along with a copy of the original receipt of purchase to Madrigal Audio Laboratories, Inc., P. O. Box 781, Middletown, CT 06457.

## Five Year Extended Warranty

The **extended warranty** for this Mark Levinson product is **five (5) years** from the date of purchase. During the warranty period, any Mark Levinson component exhibiting defects in materials and/or workmanship will be repaired or replaced, at our option, without charge for either parts or labor, at our factory. The warranty will not apply to any Mark Levinson component that has been misused, abused or altered.

Any Mark Levinson component not performing satisfactorily may be returned to the factory for evaluation. Return authorization must first be obtained by either calling or writing the factory prior to shipping the component. The factory will pay for return shipping charges only in the event that the component is found to be defective as above mentioned. There are other stipulations that may apply to shipping charges.

There is no other express warranty on this component. Neither this warranty nor any other warranty, express or implied, including any implied warranties of merchantability or fitness, shall extend beyond the warranty period. No responsibility is assumed for any incidental or consequential damages. Some states do not allow limitations on how long an implied warranty lasts and other states do not allow the exclusion or limitation of incidental or consequential damages, so that the above limitation or exclusion may not apply to you.

This warranty gives you specific legal rights, and you may also have other rights which vary from state to state. **This warranty is applicable in the United States and Canada only.** Outside of the U.S. and Canada, please contact your local, authorized Mark Levinson distributor for warranty and service information.

# Obtaining Service

We take great pride in our dealers. Experience, dedication, and integrity make these professionals ideally suited to assist with our customers' service needs.

If your Mark Levinson component must be serviced, please contact your dealer. Your dealer will then decide whether the problem can be remedied locally, or whether to contact Madrigal for further service information or parts, or to obtain a Return Authorization. The Madrigal Technical Services Department works closely with your dealer to solve your service needs expediently.



## **Important!**

---

***Return authorization must be obtained from Madrigal's Technical Services Department BEFORE a unit is shipped for service.***

---

It is extremely important that information about a problem be explicit and complete. A specific, comprehensive description of the problem helps your dealer and the Madrigal Technical Services Department locate and repair the difficulty as quickly as possible.

A copy of the original bill of sale will serve to verify warranty status. Please include it with the unit when it is brought in for warranty service.



## **Warning!**

---

***All returned units must be properly packaged (preferably in their original packing material), and the proper return authorization numbers must be marked on the outer carton for identification. If the packaging to protect the unit is, in our opinion or that of our dealer, inadequate to protect the unit, we reserve the right to repackage it for return shipment at the owner's expense. Neither Madrigal nor your dealer can be responsible for shipping damage due to improper (that is, non-original) packaging.***

---

Your dealer can order a new set of shipping materials for you if you need to ship your component and no longer have the original materials. There will be a charge for this service. We *strongly* recommend saving all packing materials in case you need to ship your unit some day.

# Specifications

*The correlation between published specifications and sonic quality is unreliable. A list of numbers reveals virtually nothing. All technical measurements must be subject to qualitative as well as quantitative interpretation.*

*Measurements of the N°30.5 yield excellent results by any standards. However, only those specifications that apply to its actual operation are included here.*

- Frequency response: 10Hz - 20kHz +0dB, -0.2dB
- Total harmonic distortion (THD): 0.001% @ 1 kHz, 0dB, A-weighted
- Dynamic range: 98dB (or better)
- Signal-to-noise ratio: 105dB
- Channel separation: Better than 110 dB
- Intermodulation distortion (SMPTE IMD): Less than 0.005%
- Digital-to-analog conversion: Two custom 20-bit DACs
- Digital filter: 8x oversampling
- Analog filter: Bessel-tuned, linear phase to 40kHz
- Low-level linearity: Deviation unmeasurable to below -70dB, approximately +1.7dB below -90dB (undithered, referenced to 0dB @ 1kHz)
- FIFO mode jitter (44.1 kHz or 48 kHz): under 20 ps, uncorrelated
- Recover mode jitter (32 kHz): under 200 ps
- Output impedance: Less than 6Ω
- Mains voltage: 100V, 120V, 200V, 220V, 240V
- Mains frequency: 50/60 Hz
- Mains consumption: 72 watts
- Overall dimensions: See "Dimensions"
- Shipping weight (2 boxes): 89 lbs. (40.37kg)
- Input complement, N°30.5:
  - 3 XLR-type female connectors
  - 2 RCA-type female connectors
  - 1 ST-type connector
  - 2 EIAJ-type connectors
  - 2 five-pin female DC connectors
  - 1 two-pin female DC connector
  - 1 RJ-45 communications port
- Output complement, N°30.5:
  - 2 pairs XLR-type male connectors (analog)
  - 1 pair RCA-type female connectors (analog)
  - 2 XLR-type male connectors (digital)
  - 1 EIAJ-type connector (digital)
  - 1 RJ-45 communications port
- Connector complement, PLS-330:
  - 2 five-pin female DC connectors
  - 1 two-pin female DC connector
  - 1 IEC mains connector

*Madrigal provides an owner-transferable, five year extended warranty on all Mark Levinson products within the U. S. and Canada ONLY. Warranty and service policies outside the U. S. and Canada are set by the local, authorized distributor and are applicable in the country of purchase ONLY. Madrigal products are designed to operate at set voltages appropriate for the country of sale and may be damaged if operated at the wrong voltage.*

# Dimensions

N°30.5 Front Dimensions

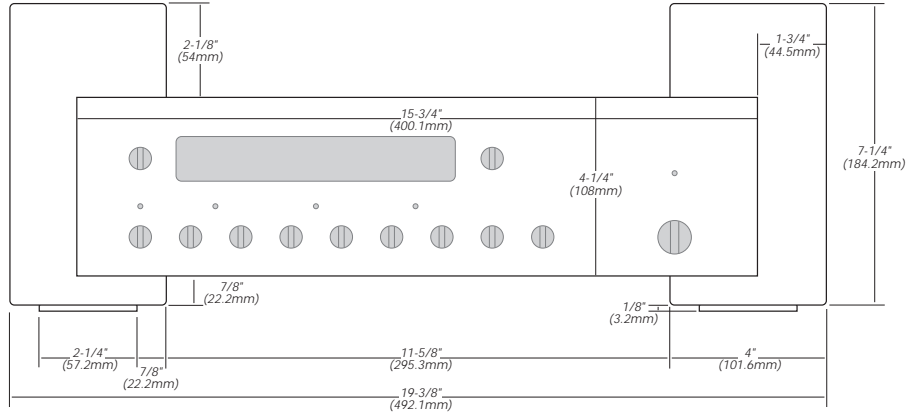

N°30.5 Rear Dimensions

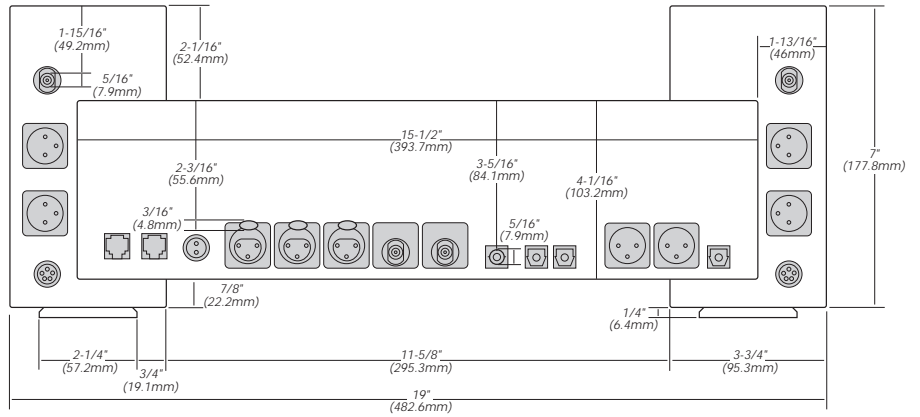

N°30.5 Top Dimensions

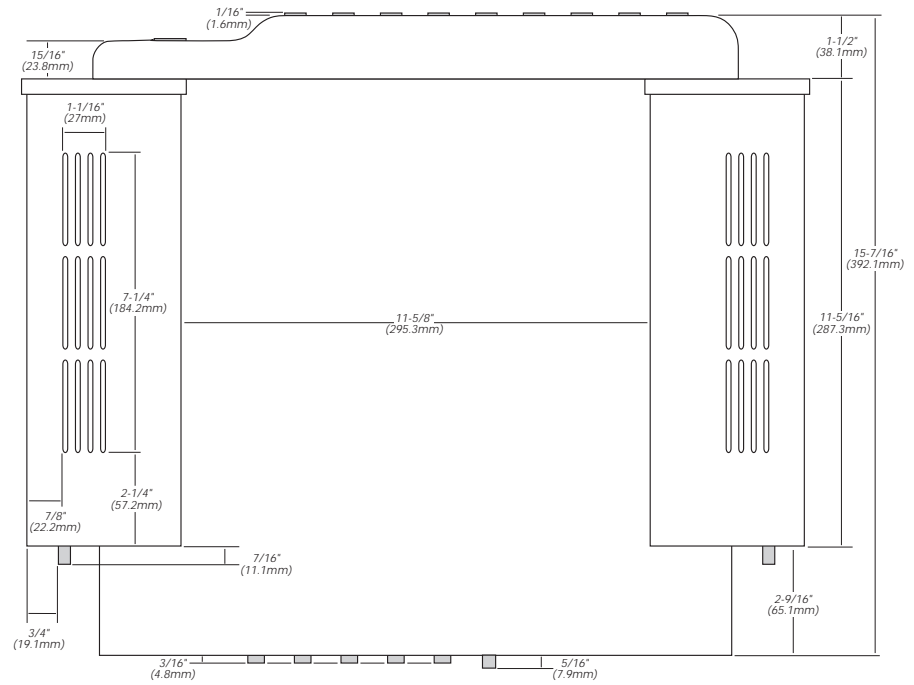

PLS-330 Front Dimensions

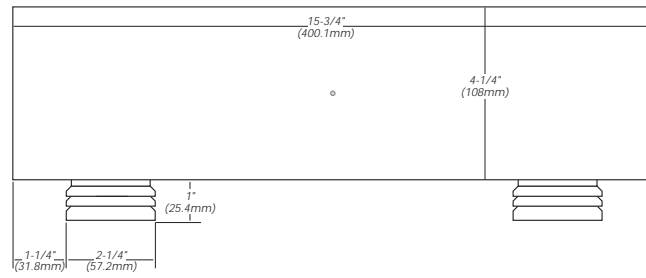

PLS-330 Rear Dimensions

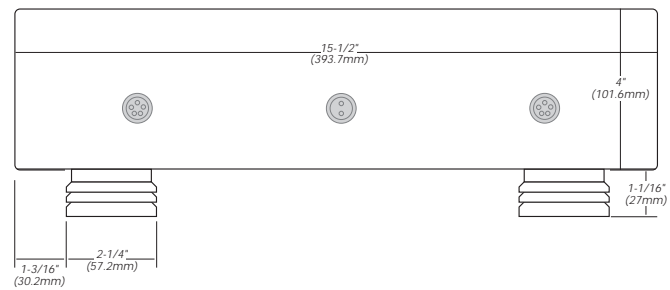

PLS-330 Top Dimensions

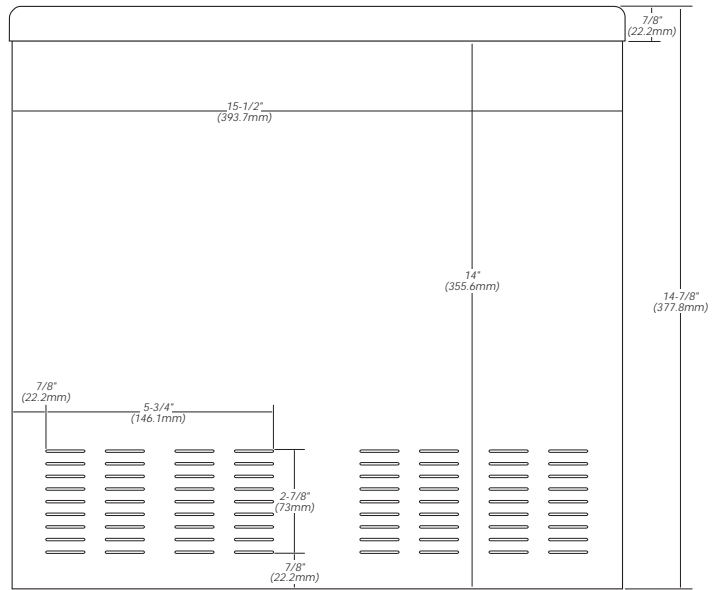



**MADRIGAL**

Madrigal Audio Laboratories, Inc.  
2081 South Main Street, P.O. Box 781  
Middletown, Connecticut 06457 USA

Telephone: (860) 346-0896  
Fax: (860) 346-1540  
<http://www.madrigal.com/>



*is a registered trademark of Madrigal Audio Laboratories, Inc.*  
**H** a Harman International company

*HDCCD® and High Definition Compatible Digital® are registered trademarks of Pacific Microsonics, Inc.*